

# Mirco Sight HS503CU User's Manual

 Multi Reticle

COLOR  Desert Sand  Matte Black



www.holosun.com

**HS503CU**

Thank you for purchasing the PARALOW HS503C-U Circle Dot Sight. Please read the User's Manual carefully.

**Important Notices**

1. Ensure that the firearm is completely unloaded and safe before device installation, sighting in, or installing a new Battery.
2. Please keep the packaging should you need to make a warranty claim.

.1.

**Model**

HS503CU

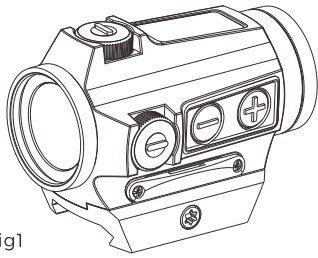

Fig1

HS503CU: New small compact circle dot sight with the option of dot only or dot with circle reticle pattern. Employing new LED technology, the life time for one CR2032 battery can be up to 10,000 hours. The sight may be installed on various firearms such as shotguns, pistols, rifles, air rifles and crossbows .

.2.

**Objective Lens**

All mirco sights have an objective lens at the front of the unit that is positioned off axis and appears to be tilted when looking at the sight. This angle of the front lens allows

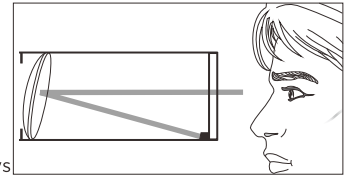

Fig2

the light generated by the LED projector inside the unit to be reflected back through the rear lens. The reflected light becomes the "dot" or aiming reference that the user sees when a red dot sight is switched on.

.3.

**Features**

- 1) Advanced LED technology: Up to 50,000 hours.
- 2) 2 Reticle Options: 65MOA circle and 2MOA dot; 2MOA dot only.
- 3) Shake Awake™ - Motion on with last setting recall. Advanced Super
- 4) Solar Technology: Power is ready for use at all times, LED can be powered by solar cell.
- 5) Parallax free, unlimited eye relief.
- 6) 12 Brightness Settings: 10DL & 2NV .
- 7) CNC milled 6061 aluminum housing and mount.
- 8) Includes a 1.63" Absolute Co-witness mount and low mount.
- 9) Waterproof: IP67.

.4.

**Multi Reticle**

The reticle for this sight is a central 2MOA dot, centered in a 65MOA circle with four positioning points. The diameter of the circle reticle represents approximately 5' 5" at 100 yards(170cm at 100m).



While in manual mode, the circle reticle can be enabled or disabled as required by pressing the "-" button for 3 seconds. when the 65 MOA circle is turned off and the sight is switched to automatic mode, the 65MOA circle will return automatically in bright light.

.5.

**Battery**

1. Operates with two-way power supply (solar cell and internal battery). The operating voltage for this device is DC3V using one high quality CR2032 Lithium battery included with purchase.

2. The high quality battery can power the device for up to 10,000 hours. Caution: The battery is not rechargeable.

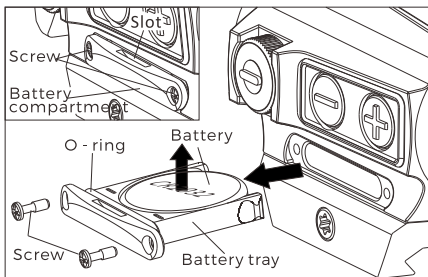

Fig 2-1

.6.

3. Battery replacement:  
1) Removing the battery (Fig 2-1):

- a) Loosen screws 1,2.
- b) Insert coin, included tool or similar object in the battery tray slot, pry out the battery tray, and remove the discharged battery by lifting it up.

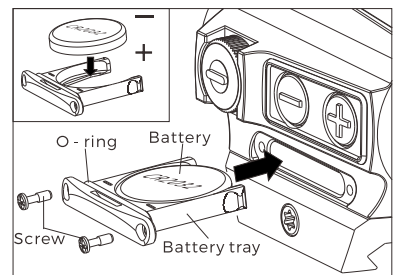

Fig 2-2

2) Battery installation (Fig2-2):

- a) Insert the battery into the battery tray by pushing it down with the correctly marked polarities, "+" and "-".
- b) Insert and press the tray into the battery compartment.

.7.

c) Tighten screws 1,2.

Caution: The loss or damage of O-ring will cause water to leak into the compartment and may damage electronic circuits and the device.

### Installation

1. The mounting bracket is adaptable to the arms with Picatinny Rail. If the arms have no Picatinny rail, or with other types of rail, Please

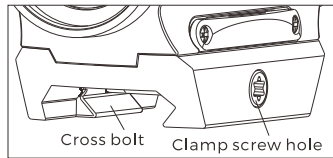

Fig 3

make extra remarks in your purchase order.

2. Firstly insert the Allen wrench into the clamp screw hole, then rotate to loosen the convex set, slide the sight into the weapon rail to a right position, and finally fasten the clamp screw. (Fig3)

.8.

switch between battery and solar cell power automatically for operation in all lighting conditions.

Auto mode operation:

a) Under auto mode, the brightness of the reticle is automatically adjusted to match ambient lighting.

b) The battery will compensate for power if the solar cell cannot drive the reticle alone.

c) If lighting is low enough, the sight will automatically switch to the battery. While running on battery, you can adjust the reticle brightness using the "+" and "-" buttons to switch between high and low brightness levels.

2) Manual Mode:

a) Press down the "+" button for 3 seconds to enter into the Manual Mode.

.10.

i. Press and hold the "+" button for 10 seconds to enter time adjustment mode. There are 4 options: 10 min, 1h, 12h or the sleep mode is disabled.

ii. Press and release either "+" or "-" button to set the time. The LED will blink (1=10 min, 2=1h, 3=12h, or 4=disable sleep mode).

iii. Press the "+" and "-" buttons simultaneously to save the time setting and power off the sight.

5.NOTE:

1) Memory function: The sight will remember the last saved brightness setting when powered on and off.

2) Low battery Warning: If the battery voltage is below 2.2Vdc, the reticle will blink slowly.

.12.

1. On top of sight is the elevation adjusting turret, windage adjusting turret is on the right side (see Fig5). The sight has been factory adjusted for approximate zero.

2. The built in screw driver tool on the protective cap can be used for zeroing adjustment (see Fig5). See label inside cap.

3. First open the protective cap, position slot type screwdriver on the slotted screw, then rotate the screw to right or left for adjustment. Each left or right click is for one adjustment equivalent to 0.5MOA value.

4. Adjust the Elevation turret counterclockwise to move the point of impact UP. Adjust the Windage turret counter-clockwise to move the point of impact to the RIGHT. Turning either turret clockwise moves the point of impact in the opposite direction.

5. Caution:

.14.

### Sight operation

Two operation modes are available: Auto mode and manual mode.

1. Switch on (see Fig4): Press and release either brightness button ("+" or "-") to turn on the sight.

2. Power off: Press the "+" and "-" buttons simultaneously will turn the power and motion sensor off.

3. Operation mode: Two operation modes are available Auto mode and manual mode.

1) Auto mode (default) - with solar cell and internal battery two-way power supply: Based upon the ambient lighting level, the sight will

.9.

b) Brightness adjustment: There are 12 settings for reticle brightness level under manual mode. Using "+" or "-" to increase or decrease the brightness.

c) Switching back to auto mode: A single press of the "+" button for 3 seconds will switch the sight to auto mode.

d) Holding down the "-" button for will cycle between the two reticle choices.

4. Sleep time mode:

1) Please note that your green dot will automatically enter into sleep mode after 10 minutes of no movement.

2) The sight will instantaneously wake up and turn on with any motion detection to last saved setting.

3) The default sleep timer setting is 10 min, but can be adjusted.

.11.

### Zero setting

Protective cap

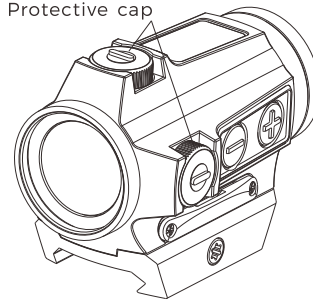

Elevation adjusting knob

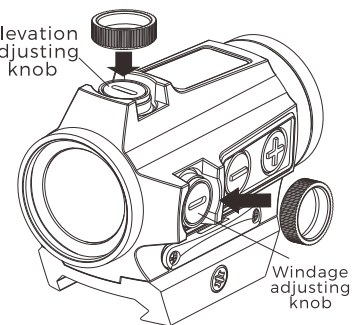

Windage adjusting knob

Fig 5

.13.

Don't try to over rotate the knobs. If you feel the knobs can-not be rotated, this indicates you have reached the adjustment limit, otherwise the device may be damaged. If the required adjusting range is beyond the limits, consider adding an extra spacer between the device and mounting rail to allow for additional adjustment.

### Maintenance and care

This device is a precision instrument that deserves reasonably cautious care. The following tips are provided to ensure long lasting use of the sight.

The optical system including the objective window and eyepiece lens which are multi-coated optical glass. When cleaning the lenses, blow away the dust on surface, wet the

.15.

lens with lens cleaner or clean water, wiping fingerprints and other oils with lens tissue, soft cotton or microfiber cloth. No special maintenance needed for housing surface. Avoid touching the glass surface with dry cloth or tissue paper. Don't use organic solvents such as alcohol or acetone. Don't try to dismantle the device as the internal parts are specially cleaned and sealed and with anti-fog treatment. Any such attempt will void the warranty. If repair needed, you can call our customer service center, or login in our website, or send email to us.

.16.

## HS503CU Mirco Sight

---

.18.

### Limited warranty

#### SUMMARY

We provide limited lifetime warranty from the date of purchase on parts and workmanship to the original purchaser. At our sole discretion, we will repair or replace product found to be defective under normal use and service without charge excluding any delivery costs, which will be born by purchaser. We will not be liable for incidental, consequential, or special damages arising out of or in any connection with the use or performance of this product. This warranty is void if the product has been misused, modified, neglected, or disassembled prior to its return. Please refer to [www.holosun.com](http://www.holosun.com) for current and complete warranty information.

.17.

