

HS515GM

Micro Sight

User's Manual



www.holosun.com

 Red Circle Dot

COLOR  Dessert Sand
 Matte Black

HS515GM

HS515GM: New small compact is a micro sight with the option of dot only or dot with circle reticle pattern. Employing new LED technology, the life time for one CR2032 battery can be up to 50,000 hours. Attached non obstructing flip-up lens covers and kill flash. The sight may be installed on various firearms such as shotguns, pistols, rifles, air rifles and crossbows.

Important Notices

1. Ensure that the firearm is completely unloaded and safe before device installation, sighting in, or installing a new Battery.
2. Please keep the packaging should you need to make a warranty claim.

.1.

Thank you for purchasing the HS515GM Micro Sight, which is a monocular inner circle dot sight. Before operation, please read the User's Manual carefully.

Model

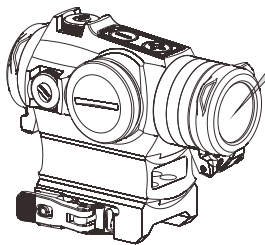

Glass Flip-backs: The flip-backs are made of toughened glass and could be used without opening the cap.



Fig1 HS515GM Micro Sight

.2.

Objective Lens

All micro sights have an objective lens at the front of the unit that is positioned off axis and appears to be tilted when looking at the sight.

This angle of the front lens allows the light generated by the LED projector inside the unit to be reflected back through the rear lens. The reflected light becomes the "dot" or aiming reference that the user sees when a red dot sight is switched on.

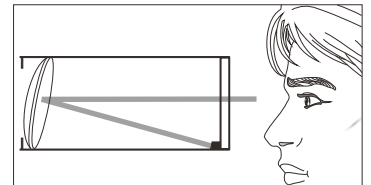

Fig2

.3.

Features

- 1) Advanced LED technology: Up to 50,000 hours.
- 2) 2 Reticle Options: 65MOA circle and 2MOA dot; 2MOA dot only.
- 3) Shake Awake™ - Motion on with last setting recall.
- 4) Parallax free, unlimited eye relief.
- 5) 12 Brightness Settings: 10DL & 2NV.
- 6) Clear glass flip-back lens caps with an integrated kill flash.
- 7) CNC Milled 7075 Aluminum housing with hard anodized finish.
- 8) Comes with a 1.63" (lower 1/3 co-witness) Detachable QD mount.
- 9) Calibration screw embedded protection.
- 10) Waterproof: IPX8.

.4.

Multi Reticle



The reticle for this sight is a central 2MOA dot, centered in a 65MOA circle with four positioning points. The diameter of the circle reticle represents approximately 5' 5" at 100 yards (170cm at 100m).

While in manual mode, the circle reticle can be enabled or disabled as required by pressing the "-" button for 3 seconds.

.5.

Battery

1. The operation voltage for this device is DC3V using one high quality CR2032 Lithium battery included with purchase.

2. A high quality battery can power this device for up to 20000 h/dot+circle, or 50000hours/dot.

Caution: The battery is not rechargeable.

3. Please see the Fig 3 for battery installation and Replacement: Battery Replacement(Fig3-1):

- 1) Rotate the battery cap counterclockwise and take off the cap
- 2) Press a side of battery then take off the battery
- 3) Install a new battery and rotate battery cap clockwise to tighten it.

.6.

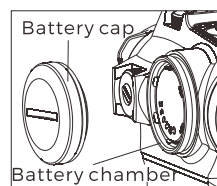
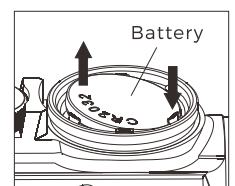

Fig 3-1



Battery Installation(Fig3-2):

- 1) Left-turning to open the battery cap.
- 2) Insert the battery into the battery chamber with the right marked polarities "+" "-". See Fig3-2. Take the waste battery out for replacement.
- 3) Rotate to close the cap.

.7.

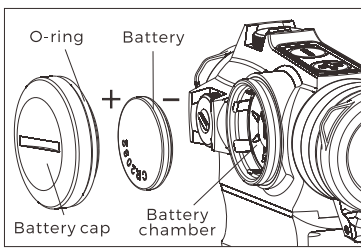

Fig3-2

Caution:
The loss or damage of the seal ring may cause water to leak into the compartment which could damage the product.

Installation on the Firearm

1. The mount bracket is adaptable to the arms with Picatinny or Weaver Rail. If the arms have no Picatinny rail, please contact a

.8.

3. Initial installation

When first installing the sight, the clamp too tight such that the handle cannot be locked. may be you must adjust clamp bolt for a proper fit:

- 1) There is one Torx socket at the end of clamp adjusting bolt on the side of the mount. (See Fig 4-2) Before installation, loosen the bolt to release clamp using included Torx wrench.
- 2) Open the cam clamp handle. Slide the sight into rail and close the clamp handle, while still loose.
- 3) Tighten the clamp adjusting bolt using the Torx wrench.

This will tighten the clamp to the rail to moderate degree. Try to open and close the clamp handle, adjusting the clamp bolt so it is neither too tight nor too loose.

.10.

- 2) The sight will instantaneously wake up and turn on with any motion detection to last saved setting.
- 3) The default sleep timer setting is 10 min, but can be adjusted.
 - i. Press and hold the "+" button for 10 seconds to enter time adjustment mode. There are 4 options: 10 min, 1h, 12h or the sleep mode is disabled.
 - ii. Press and release either "+" or "-" button to set the time. The LED will blink (1=10 min, 2=1h, 3=12h, or 4=disable sleep mode).
 - iii. Press the "+" and "-" buttons simultaneously to save the time setting and power off the sight.
5. Turn on/off the circle reticle When the battery voltage is low or other circumstances, the circle reticle can be enabled or disabled as required by pressing the "-" button for 3 seconds.

.12.

2. The built in screw driver tool on the protective cap can be used for zeroing adjustment (see Fig6). See label inside cap.
3. First open the protective cap, position slot type screwdriver on the slotted screw, then rotate the screw to right or left for adjustment. Each left or right click is for one adjustment equivalent to 0.5MOA value.
4. Adjust the Elevation turret counterclockwise to move the point of impact UP. Adjust the Windage turret counterclockwise to move the point of impact to the RIGHT. Turning either turret clockwise moves the point of impact in the opposite direction.
5. Caution:
Don't try to over rotate the knobs. If you feel the knobs cannot be rotated, this indicates you have reached the adjustment limit.

.14.

qualified gunsmith.

2. Designed with our patented nonlinear cam clamping system, no tools are required for attaching to a rail. Push locking button, lift up handle to loosen the locking bar.

To mount sight on rail, push the handle down, locking button will automatically engage. The installation is complete. (see fig 4-1)

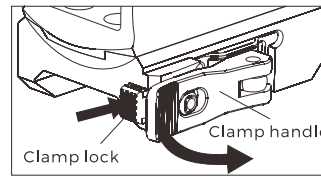

Fig 4-1

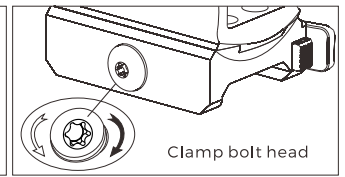

Fig 4-2

.9.

Sight operation

1. Switch on (see Fig5) : Press and release either brightness button ("+" or "-") to turn on the sight.
2. Power off: Press the "+" and "-" buttons simultaneously will turn the power and motion sensor off.
3. Brightness adjustment: There are 12 brightness settings. The default brightness is the 7th level. Pressing the "+" or "-" button until the circle reticle has a sufficient intensity to contrast against the target. One quick press and release changes brightness.
4. Sleep time mode:
 - 1) Please note that your green dot will automatically enter into sleep mode after 10 minutes of no movement.

.11.

6. Note:

- 1) Memory function: The sight will remember the last saved brightness setting when powered on and off.
- 2) Low battery Warning: If the battery voltage is below 2.2Vdc, the reticle will blink slowly.

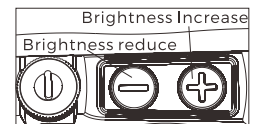

Fig 5

Zero setting

1. On top of sight is the elevation adjusting turret, windage adjusting turret is on the right side (see Fig6). The sight has been factory adjusted for approximate zero.

.13.

otherwise the device may be damaged. If the required adjusting range is beyond the limits, consider to add extra spacer between the device and mount/rail to expand the adjusting range limits.

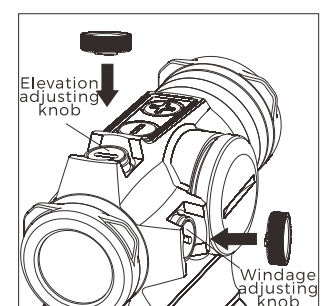
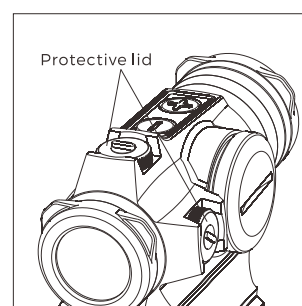

Fig 6

.15.

Maintenance & care

This device is a precision instrument that deserves reasonably cautious care. The following tips are provided to ensure a long product life. The optical lenses are multicoated optical glass. When cleaning the lenses, blow away the dust on the surface, wet the lens with lens cleaner or clean water, then wipe away smudges with lens tissue, soft cotton or a microfiber cloth. Avoid touching the glass surface with dry cloth or tissue paper. Do not use organic solvents such as alcohol or acetone. No special maintenance is needed for the housing surface. Do not try to dismantle the device as the internal parts are specially cleaned and sealed and with an anti-fog treatment. Any such attempt will void the warranty.

.16.

Limited warranty

We provide a limited lifetime warranty from the date of purchase on parts and workmanship to the original purchaser. At our sole discretion, we will repair or replace products found to be defective under normal use without charge, excluding any delivery costs, which will be born by purchaser. We will not be liable for incidental, consequential, or special damages arising out of or in any connection with the use or performance of this product. This warranty is void if the product has been misused, modified, neglected, or disassembled prior to its return. Please refer to www.holosun.com for current and complete warranty information and other conditions.

.17.



HOLOSUN®

Holosun Technologies Inc.

www.holosun.com

Customer Service

Phone: 909-594-2888

Email: warranty@holosun.com

V1.3