

# ELEMENT<sup>®</sup>



## TITAN 5-25X56 FFP

### OWNER'S MANUAL & RETICLE INFORMATION

# Index:

1)	Introduction – Meet the TITAN	1
2)	Mounting your Riflescope	2
	–Choosing Rings	
	–Alignment & Eye Relief	
3)	Riflescope Adjustments	4
	–Diopter: Focusing the Reticle	
	–Parallax Knob: Focusing the Target	
	– Illumination	
	–Adjusting Magnification	
	–Fitting/Removing Throw Lever	
4)	Zeroing your Riflescope	8
	–Adjusting the Turrets	
	–Boresighting	
	–Fine Tuning	
	–Setting your Zero–Stop	
	–Setting the Position of the Turret Housing	
5)	Understanding Units: Milliradians & Minutes of Angle	12
6)	Reticle Options	14
7)	Warranty Information & Spec Sheet	17

## MEET THE TITAN.

The TITAN puts your money where it matters, with precision-engineered internals and a turret system superior to other products in the same price class. To make things even better, we've gone one step ahead and given the Titan a 34mm tube and ED glass. The 34mm tube allows for a greater elevation/windage range when dialling for those crazy long shots, and the 56mm Objective lens with ED glass provides you with an ultra-sharp, clear image with a large field of view. The turret system has been upgraded from your stock-standard sporting optic to feature stainless steel internals for resistance against wear-and-tear when dialling regularly – something that modern shooting disciplines require. We've introduced quality control checks to give you peace of mind when taking that 1000 yard shot, and if something goes wrong, our Platinum Lifetime Warranty has you covered!

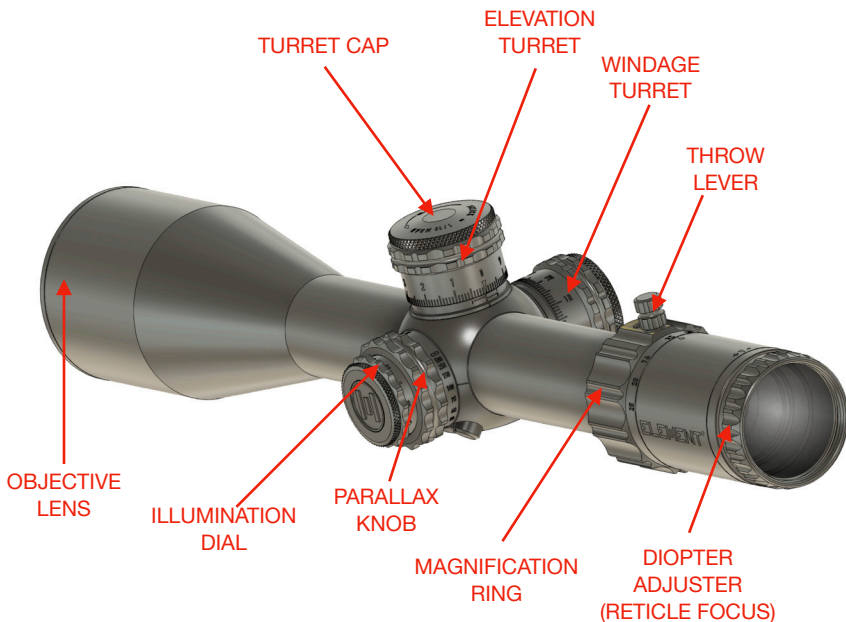

Your rifle system is only as good as its weakest point, and so mounting of a riflescope is a very critical process that requires time and precision. If you feel uncomfortable doing this yourself we suggest visiting a gunsmith, as incorrect mounting can cause many issues down the line.

## Choosing Rings

The TITAN requires 34mm rings. When purchasing rings for this riflescope, choose a quality product - Inferior rings may not align correctly and can damage your scope.

Ensure that your rings are the correct height above the bore & action for safe clearance and a comfortable cheek weld.

We recommend using a 20 MOA base, or adjustable rings if shooting at extended ranges. NEVER USE SCOPE SHIMS, as these can cause damage to your body tube and void your warranty.



## Alignment & Eye Relief

- 1) When fitting the riflescope to your rifle, ensure that the rings are firmly attached to the rifle **BEFORE** you tighten the top screws down.
- 2) With the riflescope in place, torque the screws down until you begin to feel some resistance, but make sure you are still able to move the riflescope back and forth.
- 3) Get behind the rifle in a shooting position and move the riflescope forward or backward until the eye relief is best suited to your position.
- 4) With the eye relief set, use a set of bubble levels or a plumbline to ensure that the riflescope is level. A canted reticle will cause point of impact drift to the left or right, and affect accuracy.



- 5) Once you are happy with the position of your riflescope, begin to torque down your rings in a criss-cross pattern, moving between screws and turning small amounts at a time. This will ensure that the riflescope does not shift position while tightening.

Use a torque spec of **15-18 in-lbs (1.7-2.0 nm)** to avoid damage to the body tube!

## Diopter – Focusing the Reticle

Everybody's eye is different, and the ocular lens will need to be adjusted for your eye in order for the reticle to appear in focus.

To do this, point the riflescope towards a blank or featureless background (i.e. a white wall or blue sky) and turn the ocular adjustment ring clockwise and counter-clockwise until the reticle appears in optimum focus.

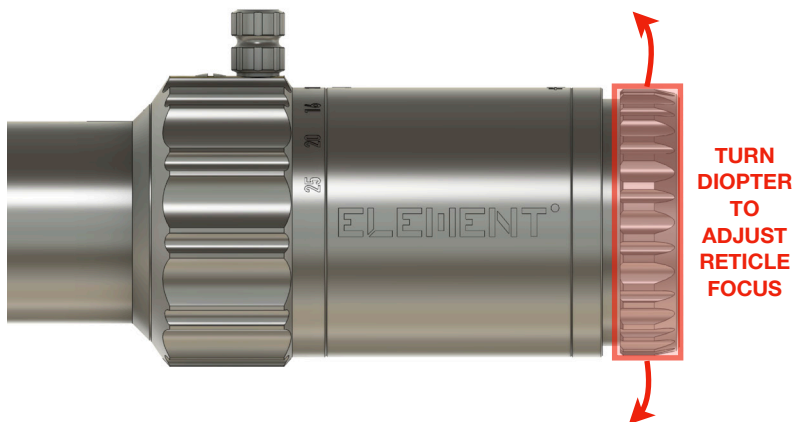

**Tip:** Your eye will try to compensate for an out-of-focus reticle, so it may help to turn your parallax to minimum and look towards a far-off background. This will blur the background and allow your eye to focus on the reticle itself.

## Parallax Knob - Focusing the Target

A well-adjusted parallax is crucial for optimum precision, as it places the reticle in the exact same focal plane as the target and “fixes it in place”, eliminating the possibility of parallax error. And, of course, it allows you to see your target clearly.

To adjust parallax, rotate the parallax knob until your target is in focus. The parallax wheel is marked for different distances between 10yds/m to infinity. These markings provide an indication of where your optimum parallax setting might be for a given distance, but will not always be 100% accurate as your ocular lens adjustment will affect the location of the focal plane. It is better to use your eye for such adjustments.

**TURN PARALLAX KNOB TO ADJUST  
IMAGE FOCUS**

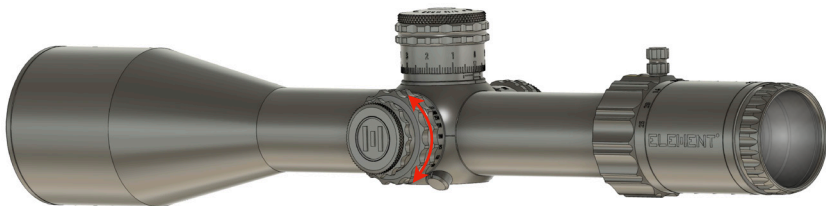

**Tip:** Place your riflescope in a fixed position and change the position of your eye (up/down, left/right) while adjusting parallax. If parallax is not set correctly, there will be apparent movement of the reticle in relation to the target. Adjust the parallax until this movement is eliminated.

## Illumination

The Titan features an illuminated reticle. Remove battery cap to expose battery housing. The illumination unit uses a **CR2032** battery.

## Adjusting Magnification

The TITAN features a magnification of 5-25x, and can be adjusted using the magnification ring near the rear of the riflescope.

The ring is marked with magnification powers from 5x up to 25x, and will line up precisely with the arrow on the ocular tube to indicate magnification.

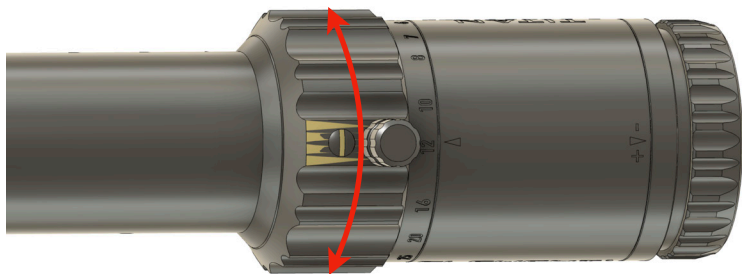

The TITAN is a First Focal Plane riflescope, which means that the subtensions of the reticle will remain the same regardless of the magnification. In other words, the magnification setting is not crucial for precision when using the reticle.

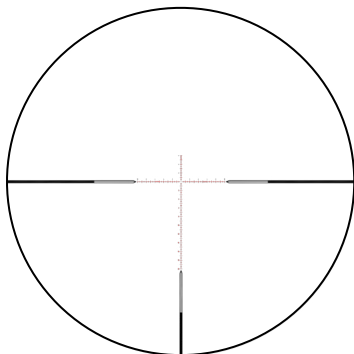

FOV: 5x

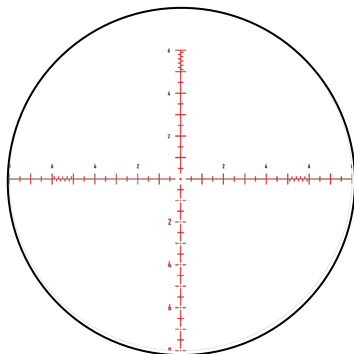

FOV: 25x



### Fitting/Removing the Throw Lever

Each TITAN riflescope comes standard with a throw lever that enables fast adjustment of the magnification ring. This can be removed simply by unscrewing and replacing with the included hex screw.



Your TITAN will need to be zeroed after it has been fitted to your rifle. The first step is to remove your turrets and remove the zero stop mechanism to allow a full range of adjustment.

1) Remove the Turret Housing

The TITAN is fitted with tool-free turret housings that can be removed by hand. With one hand holding the turret firmly in place, turn the knurled portion of the locking cap anticlockwise with your other hand until it lifts out. With this piece removed, you can lift off the turret housing to expose the zero-stop mechanism.



2) Remove the Zero-Stop Mechanism

To remove the zero-stop mechanism, use a 1.5mm hex key to loosen the three locking screws, and then lift the zero-stop mechanism off. Keep it somewhere safe! Replace the turret housing to continue.



## Adjusting the Turrets

Your TITAN will either be an MOA model, or an MRAD (MIL) model. These are two different angular units of measurement that are used by precision shooters. For in-depth information on these different units, see the guide on page 12. If you have an MRAD model, your turrets should read “1 Click = 1/10 MRAD”, while MOA models should read “1 Click = 1/4 MOA”. In simple terms, 1 click on an MOA turret will move the reticle 1/4” at 100 Yards, and 1 click on an MRAD turret will move the reticle 1 cm at 100 Meters.

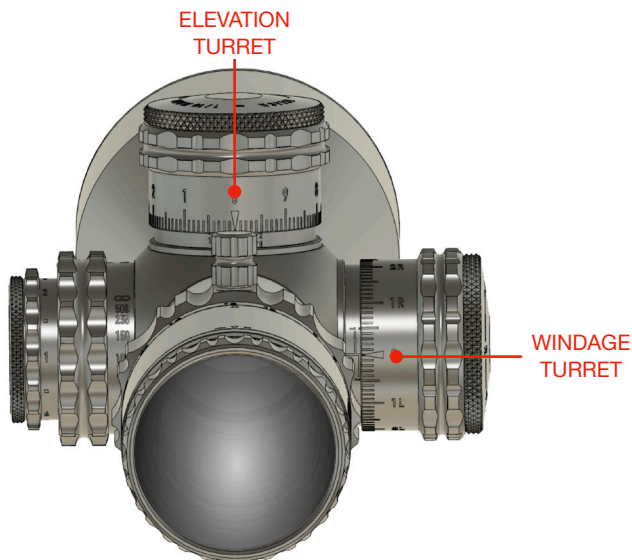

- To move your Point of Impact UP, turn ANTI-CLOCKWISE on your ELEVATION TURRET.
- To move your Point of Impact DOWN, turn CLOCKWISE on your ELEVATION TURRET.
- To move your Point of Impact RIGHT, turn ANTI-CLOCKWISE on your WINDAGE TURRET.
- To move your Point of Impact LEFT, turn CLOCKWISE on your WINDAGE TURRET.

## Boresighting

The TITAN is optically zeroed at the factory, so it should be close to center when fitted. Even so, it is important to check that you are “on paper” to avoid frustration. Bore-sight your rifle to ensure that your reticle is roughly aligned before fine-tuning. If using an airgun, shoot a large target at a close distance to check basic alignment.

## Fine-Tuning your Zero

We’ve designed the TITAN with reticle and turret units matching each other, which will make fine-tuning your zero an easy process. You can use your reticle to measure your Point of Impact offset from your target, and adjust accordingly.

For example, if your POI is 10 MOA Low and 5 MOA Right, you will adjust your turrets 40 clicks (10 MOA) UP and 20 clicks (5 MOA) LEFT to shift your reticle position to match your POI. Some reticles even feature a small 1-click scale so you can measure to the nearest click!

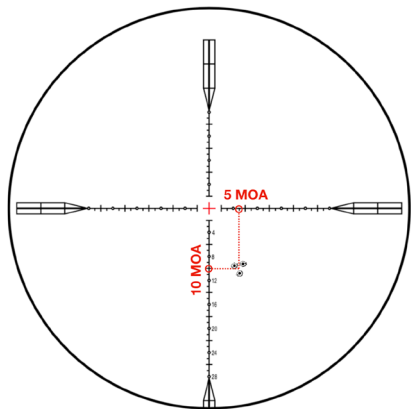

We recommend taking a 3-shot group to confirm your zero before continuing to the next step.

**Tip:** We recommend a zero distance of 100yds/m for centerfire rifles, 50yds/m for rimfires and 20-50yds/m for airguns. If you cannot boresight your rifle, start at a closer distance to get on paper, and then move out further to make precise adjustments.

## Setting your Zero-Stop

The TITAN is fitted with a zero-stop mechanism to make returning to zero an easy process. After dialling your elevation turret for a long-range shot, the zero stop will allow you to return to zero without even looking at your turrets.

- 1) Once your turrets have been zeroed, remove the turret housing and fit the zero-stop mechanism in place, with the steel pin facing **DOWN**. Make sure that your turrets do not rotate at all (click) during this step.
- 2) Rotate the zero-stop ring **clockwise** while maintaining downward pressure. **You will feel a hard stop as the pins engage.**
- 3) Tighten the three locking screws with a 1.5mm hex key to lock in position.



## Setting the Position of the Turret Housing

You will want to set your turret housing so that the “0” on your turret lines up with the indicator.

- 1) Line up the “0” on the turret housing with the indicator line and push it down into position. The teeth on the turret housing will match up with the teeth on the turret rod.
- 2) With one hand holding the turret firmly in place, screw the turret cap firmly down to lock it into place.



With your turrets set, you will now be able to use data from ballistics calculators and dial your turrets for long-range shooting instead of using reticle holdover!

While it is possible to use your rifle scope without understanding how these systems work, it is best to know the basic concepts, as they are an integral part of “Shooting Education”, and will help you get the best out of your rifle scope.

The two units we use in the shooting world are Milliradians (MRAD or MIL for short) and Minutes of Angle (MOA for short). The concept behind these two is very similar: They are angular units of measurement, meaning they can be used at any distance to quantify the distance between turret clicks and reticle markings.

Technically speaking, one MRAD = 1/1000 of a Radian, and one MOA = 1/60 of a Degree. But that doesn't help us.

Let's look at these units in terms of how they correspond to reticle divisions at different distances. In simple terms, ONE MRAD = 10cm at 100m, and ONE MOA = 1.047" at 100yds. This makes these two units very useful, because we can relate them to units of measurement we use every day.

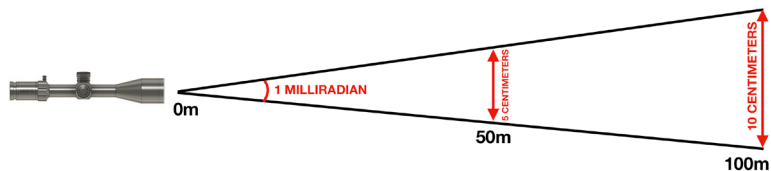

A shooter practicing at a 100m range can easily measure his group size in cm through the scope using his MRAD reticle, and a shooter at a 100yd range can estimate his group size in Inches using an MOA reticle.

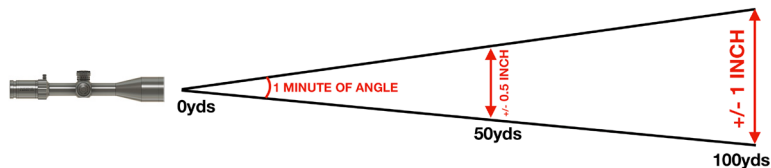

This is also incredibly useful for measuring your POI offset when zeroing your scope, or even measuring the size of an animal when hunting. But there is some mental maths involved. Because these are angular units of measurement, the corresponding length units will change depending on your distance from the target. For example, at 1000 Meters, one MRAD will now span 100cm (1m) instead of 10cm, and at 1000 Yards, 1 MOA will span 10.47" instead of 1.047". And the same applies the other way round: at 50m, one MRAD will span 5cm and 1 MOA will span approximately half an inch.

Most riflescope turrets are divided up into smaller units for more precise adjustments.

The TITAN features 1/10 MRAD and 1/4MOA click adjustments. Again, let's break that down:

MRAD model: 1 Click at 100m = 1cm

MOA model: 1 Click at 100yds = Approx. 1/4"

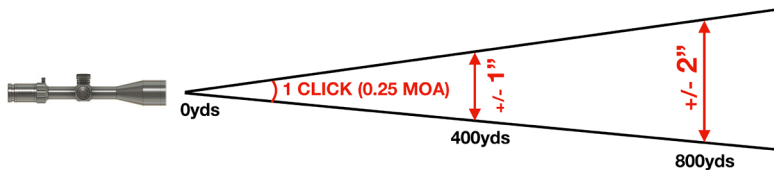

The TITAN is available with 4 different reticle options.

MOA: EHR-1C and EHR-2D

MRAD: APR-1C and APR-1D

These can be easily categorised into two categories: Simple and Complex. The “simple” reticles (APR-1C and EHR-1C) are better suited to shooters that prefer dialling their turrets and don’t plan to hold over much. The “complex” reticles, (APR-1D and EHR-2D) are better suited to shooters who prefer to use the reticle for hold-off shooting and need more aim points.

A long-range hunter who has time to dial the turret precisely will not need any aim points besides the centre crosshair, while a NRL or PRS shooter competing under time pressure may prefer to hold instead of dial. The choice is yours!

## MRAD Reticles: APR-1C & APR-1D

With so many reticle options nowadays, it is difficult to find something that can be used for all situations. Element’s reticles have been designed by hunters, competition shooters and plinkers - We do it all, and we’ve done our best to design all-purpose reticles that are useful without being too “cluttered”. APR stands for “All-Purpose Reticle”, and has been designed with some intuitive features:

- 1/10 MRAD scale on the vertical & horizontal axis for measuring group size
- Center dot for clarity when engaging small targets
- Numbered markings for fast holds in stressful situations
- Windage dots below the crosshair for more precise wind holds (APR-1D)

## MOA Reticles: EHR-1C and EHR-1D

“EHR” stands for Expedited Hold Reticle, and is designed to help the shooter find his hold point faster & easier by implementing three different shapes (circle, large hash, small hash) on the X and Y axes. The same applies to the differently-sized floating dots on the EHR-2D. Reticle dimensions were carefully selected to achieve clarity without sacrificing precision. The floating centre crosshair creates a clean aim-point for target shooting.



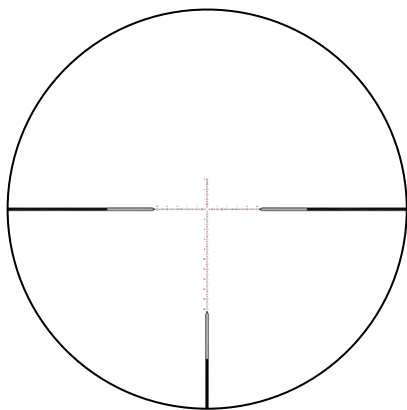

5x

APR-1C

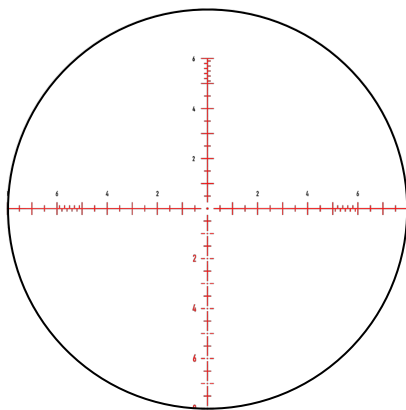

25x

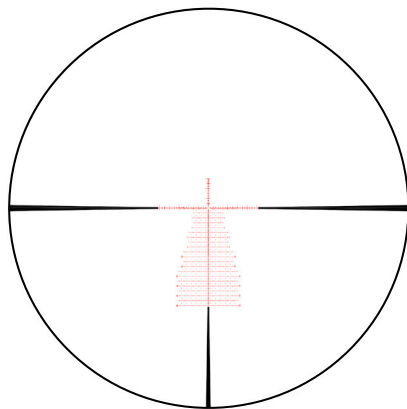

5x

APR-2D

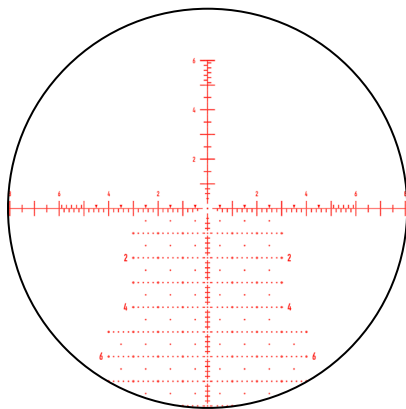

25x

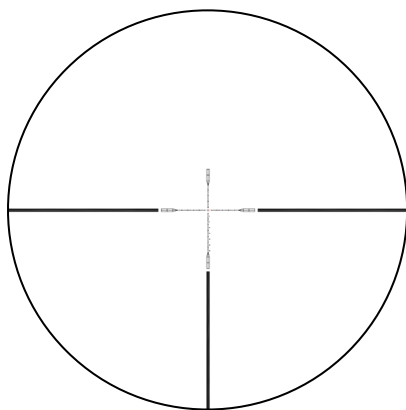

5x

EHR-1C

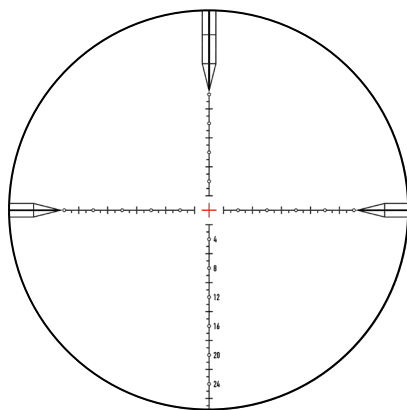

25x

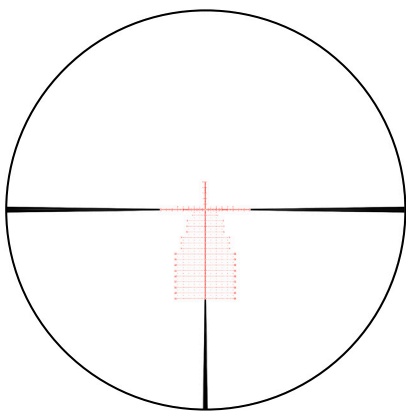

5x

APR-2D

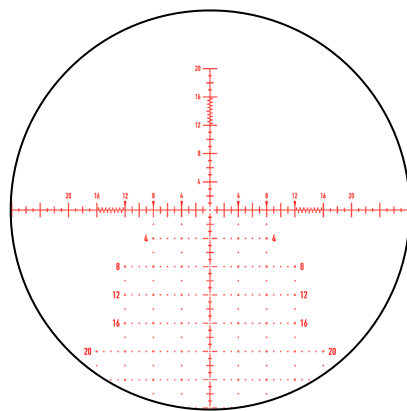

25x

As shooters, we know that there is nothing worse than being let down by your equipment. We have made every effort to build a rugged, reliable product that will not break under any normal circumstances, and have implemented some of the strictest quality control measures in the industry. However, we know that things can go wrong, and therefore ALL ELEMENT Riflescopes are covered by our PLATINUM LIFETIME WARRANTY. This includes lifetime cover for any riflescopes damaged through normal use, and requires no registration, proof of purchase or transfer. If you have a problem, we will fix it - It's that easy!

For any warranty claims, please contact [support@element-optics.com](mailto:support@element-optics.com)

USA:

ELEMENT OPTICS USA  
3024 Hall Watters dr.  
Wilmington, NC  
USA

INTERNATIONAL:

ELEMENT OPTICS EUROPE  
Västerångsvägen 10  
54235 Mariestad  
SWEDEN

The Element Optics PLATINUM LIFETIME WARRANTY applies to riflescopes only, and does not cover accessories. Theft, loss, deliberate damage and cosmetic damage that does not hinder the operation of the riflescope is not covered. If your product can not be repaired and a replacement model is no longer in production, a model of equal value will be substituted.

# SPEC SHEET

MAGNIFICATION RANGE	5-25x	
TUBE DIAMETER	34mm	
OBJECTIVE LENS DIAMETER	56mm	
EXIT PUPIL	11.2-2.1mm	
EYE RELIEF	3.74-3.54"	
FIELD OF VIEW	@100yds: 24.6-4.9ft	@100m: 8.24-1.64m
CLICK VALUE	1/4 MOA (25 MOA / REV)	1/10 MRAD (10 MRAD / REV)
ELEVATION ADJUSTMENT RANGE	90 MOA	26.2 MRAD
WINDAGE ADJUSTMENT RANGE	50 MOA	14.5 MRAD
MINIMUM PARALLAX	15 YDS	15 METERS
LENGTH	15.16"	385mm
WEIGHT	39oz	1105g



@WeAreElementOptics



Element Optics



element\_optics



[www.element-optics.com](http://www.element-optics.com)