



TACTICAL 8X RIFLESCOPES

1-8x24i TAC

gp-optics.com

Gebrauchshinweis / Garantie	Deutsch
Instruction for use / Guarantee	English
Modo d'emploi / Garantie	Français
Instruzioni d'impiego / Garanzia	Italiano
Mode de empleo / Garantia	Español
Bruksanvisning / Garantie	Swenska
Kayttöohje / Takuu	Norsk
Pokyny k používání / záruka	Dansk

Dear customer,

We are delighted that you have chosen our TACTICAL 8X riflescope and would like to thank you for trusting in our products. It is important for us to provide you with the best product and if ever needed, the best service support available so that you can enjoy your outdoor passion to the fullest.

Enjoy your Passion

Repairs should be solely handled by an authorized repair location or GPO GmbH & Co. KG. The improper and unauthorized usage, disassembly or repair of the products by a non-authorized repair business may result in the termination of this product's warranty.

Safety Instructions



Please carefully read these safety instructions and follow these guidelines when using this product.



Never look directly into the sun, bright light sources or laser based light sources through your riflescope or any other optical product. This can cause irreparable eye damage. Optics in riflescopes function as a magnifying glass, therefore dramatically increasing the intensity of the light source.



Store the riflescope and all accessories included with this product out of reach of children. Some of our products may contain small parts which could create a choking hazard for small children, or nylon straps which could create a strangulation hazard.



Be cautious when touching metal parts when the product has been stationary and extensively exposed to the sun or the freezing cold, as extremely hot or frozen metal components may cause an injury to exposed skin.



After using this product, always use the protective cover provided to avoid accidental light magnifying, which may create a fire.

Avoid improper shock, such as dropping this product. It is an optical instrument and damage may occur.

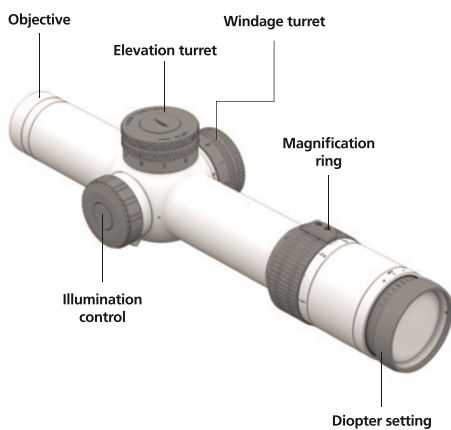

Information before using this product

To avoid unnecessary mounting complications, please have this riflescope mounted by an authorized dealer, a certified gunsmith or make sure your scope mounting skills are sufficient to eliminating mounting damage.

Make sure that the firearm is unloaded and safe while the riflescope is being mounted onto the firearm.

Make sure all mounting screws that attach the riflescope to the rifle are tight before firing the rifle and that the rifle has been properly sighted in. Loose mounts will result in bullet impact shifts.

Please make sure that the riflescope works properly before using it on your firearm. Check all optical features such as parallax adjustment, fast focus ocular, turret caps and turret adjustment rings. It is important that the riflescopes parallax and fast focus is adjusted properly so you can see a sharp image when looking through the riflescope.

Before firing the rifle, be sure that the riflescope is mounted with enough distance between the riflescope and your eye. Improper mounting may cause injury during recoil.

Your authorized dealer or a GPO GmbH & Co. KG technical service representative will be pleased to answer any questions you may have.

Parallax Compensation

Since the reticle image and the target image are on different focal planes, it is difficult for the eye to reproduce both images at different distances sharply. Therefore, select riflescopes are equipped with parallax compensation for long distances and higher magnifications. Parallax adjustment will join these 2 images, making a single sharp target and reticle image at the same time. Therefore, you will need to adjust the sharpness of the reticle first with the ocular diopter ring. Then, you will need to adjust the parallax which will sharpen the target image to meet the reticle image. Riflescopes with no parallax compensation are adjusted to 100 meters/110 meter.

Adjustment of the riflescope image, riflescope without parallax compensation

Select an object and look through the riflescope. Use the highest magnification on the riflescope during this process. Turn the diopter adjustment (ocular focus ring) to make the reticle sharp. Focusing the riflescope at the highest magnification will always provide a sharp reticle at the lower magnification range. Riflescopes with no parallax compensation are adjusted to 100 meters.

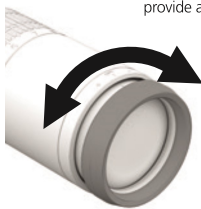

Bildposition 1
Diopter setting

Adjustment of the riflescope image, riflescope with parallax compensation

If you have a riflescope with parallax compensation select a distant object over 300 meter and look through the riflescope. Adjust the diopter ring (ocular focus) to generate a sharp reticle image. Tip: Best is to choose a blank clear sky or cover the objective with a tissue, then focus the reticle with the ocular diopter ring. This way your eye is not confused to attempt to focus on the reticle and the distant object at the same time.

Afterwards, adjust the sharpness of the object using the parallax compensation. This process will assure focal images are aligned and accuracy is maximized. For a rough orientation, you can also use the engraving of the different distances on the parallax compensation, but these distances on the parallax adjustment ring are only estimates and further fine-tuning focusing of the image is usually needed.

Magnification adjustment ring

You can seamlessly switch between different magnifications by turning the magnification ring, located on the front of the ocular housing. The engraved numbers on this ring will define the exact magnification that the riflescope is set on.

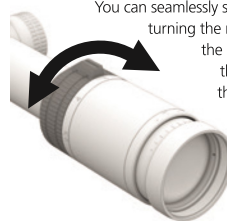

Bildposition 2
Magnification

Elevation and windage adjustment of your point of impact

Riflescopes have adjustment dials (turrets) that will assist you in changing the point of impact of your bullet, so it can be adjusted to hit directly where your center reticle image is pointing. Elevation turret adjustments (top) and windage turret adjustments (side) allow you to make these adjustments while sighting in your rifle.

The adjustment per click on the elevation and windage turret of all TACTICAL 8X riflescopes is 1 cm on 100 meter.

The TACTICAL 8x telescopic sight features lockable elevation and windage turrets. In order to calibrate the elevation and windage adjustment, pull out the respective turret. You can now carry out the calibration. Afterwards, press the turret back down. The turret is now locked again.

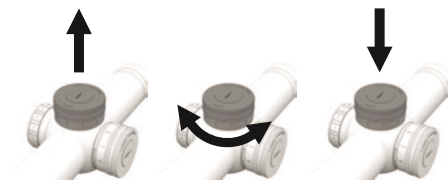

Adjustment of the riflescope to the bore of the barrel

Please have your riflescope mounted and adjusted by an authorized dealer or make sure the riflescope is mounted assuring proper mounting procedures. Mounting the riflescope properly will assure shooting and sighting results are positive and will minimize the risk of injury. It is important to make sure proper eye distance to the scope (eye relief) is maintained during mounting and shooting. For detailed instructions on eye relief and proper mounting, see a certified gunsmith or contact a GPO GmbH & Co. KG technical specialists.

Factory tips:

- This riflescope is equipped with a mechanically middle centered reticle. This insures that the reticle image will always stay in the middle of the optical image.
- It is important to zero in the riflescope if you purchase it new, if it has been repaired or if other changes such as changes to the bullet drop have been made. It is also important to zero the rifle if the scope has been removed from the ring/base system then put back in place. Removing the scope from the ring or from the rifle will change the zero.

Elevation top adjustment

The TACTICAL 8X riflescopes are equipped with turrets that will adjust your bullet point of impact by a 1 cm at 100 meter with every click. If you want to zero this riflescope, please do the following:

1. At a shooting range fire a group of 3 shots at the center of a target that is 100 meter away. These 3 shots create a bullet group and it is the center of this group that will need to be adjusted to the center of the target. Best is to not make individual turret adjustments after every shot, since individual shot placements can vary. Adjusting the group to center adjusts the average to center, so individual shots outside the average group do not cause you to over/under adjust the scope.
2. Estimate where the center of the group is on the target.
3. If the center of the group is 10 cm below the center line of the target, then the group needs to be adjusted up (elevation) 10 cm. 1 click will move the group 1cm at 100 meter, so 10 clicks will move the group 10cm at 100 meter. Adjust the turret in the specified direction you want the bullet group to move.

Repeat 3 shot group procedure to ensure proper group elevation placement on the target.

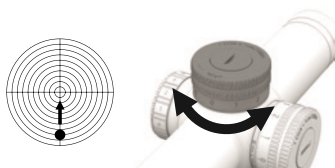

TACTICAL 8X riflescope turrets have a function where you can set the "0" on the turret dial to exactly align with the scope indicator mark on the scope body. This is not required for sighting in. However, utilizing this function will assure the shooter that the turret dial has not been bumped or moved from the zero established on the rifle range. This way, if you need to make adjustments in the field, you can always return to your exact zero that you established on the rifle range. Follow these four steps:

1. After the riflescope has been sighted in on the rifle range, unscrew the center screw on the top of the elevation turret and slightly lift the turret upwards, removing it from the internal gearing.
2. Rotate the turret off the gears to align the 0 on the riflescope to the scope body adjustment indicator mark.
3. Press the turret down to engage the internal gearing system.
4. Replace center screw.

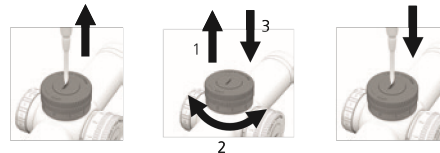

Windage side adjustment

The TACTICAL 8X riflescopes are equipped with turrets that will adjust your bullet point of impact by 1 cm at 100 meter with every click. If you want to zero this riflescope, please do the following:

1. At a shooting range fire a group of 3 shots at the center of a target that is 100 meter away. These 3 shots create a bullet "group" and it is the center of this group that will need to be adjusted to the center of the target. Best is to not make individual turret adjustment after every shot, since individual shot placements can vary. Adjusting the "group" to center adjusts the average to center, so individual shots outside the average group do not cause you to over/under adjust the scope.
2. Estimate where the center of the "group" is on the target.
3. If the center of the group is 10 cm to the right of the center line of the target, then the group needs to be adjusted left (windage) 10 cm. 1 click will move the group 1 cm at 100 meter, so 10 clicks will move the group 10 cm at 100 meter. Adjust the turret in the specified direction you want the bullet group to move.
4. Repeat 3 shot group procedure to ensure proper group windage placement on the target.

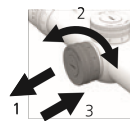
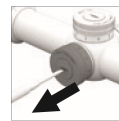
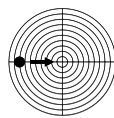

TACTICAL 8X riflescope turrets have a function where you can set the "0" on the turret dial to exactly align with the scope indicator mark on the scope body. This is not required for sighting in. However, utilizing this function will assure the shooter that the turret dial has not been bumped or moved from the zero established on the rifle range. This way, if you need to make adjustments in the field, you can always return to your exact zero that you established on the rifle range. Follow these four steps:

1. After the riflescope, has been sighted in on the rifle range, unscrew center screw on the side of the windage turret and slightly lift the turret left or right, removing it from the internal gearing.
2. Rotate the turret off the gears to align the 0 on the riflescope to the scope body adjustment indicator mark.
3. Press the turret down to engage the internal gearing system.
4. Replace center screw.

Illumination

Select TACTICAL 8X riflescopes come with an iCONTROL™ reticle illumination system. The reticle illumination is a fiber optic feature of your riflescope. The illumination dot helps you aim at game, helps you see the reticle in extremely low light situations, and assists in exact shot placement on targets that are very dark (e.g. black bear).

The illumination can be adjusted simply, and set to whatever brightness the shooter prefers, daylight or dusk. To adjust the illumination intensity, simply rotate the illumination regulator.

The iCONTROL™ illumination system has an electronic power management built in. This system will automatically turn off the illumination dot after 3 hours of no regulator adjustments. This "auto off" function will dramatically save battery life. In addition, the electronic system has a capacity indicator. When the battery reaches 15 % remaining battery capacity left, the illumination point will blink 3 times when switching on the illumination dot. This is an indicator that your battery is running low and needs replacement. After the 3-blink indicator, the illumination dot functions normally.

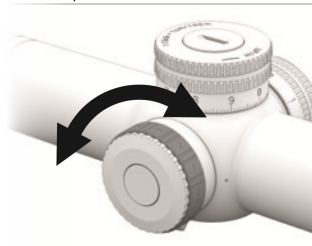

Change of batteries

Unscrew the battery cap. Replace the battery with a new battery. Make sure you can see the + pole of the battery after putting it in the battery slot. Screw the battery cap on the illumination button.

The batteries for the illumination are standard CR2032 batteries. Please dispose of the used batteries in an environmentally appropriate way.



Care, cleaning and maintenance

You can clean the optics of your product with the optical micro-fiber cleaning cloth provided with your product, or by using other lens cleaning equipment solely intended for optical cleaning purposes.

Be sure to keep the optical surfaces clean and immediately remove any dirt or oil debris caused by grease (finger prints), oil or water spots to guarantee consistent optical quality.

To clean the exterior lenses of your product, be sure to first remove any granular dirt or debris that may cause scratching during the cleaning process. Be aware that rough granular dirt particles must be removed with either an air bellows or a clean hair brush. Otherwise, this may lead to damage of the optical coating or scratches on your lens.

Once large debris is removed, slightly breath onto the optical surfaces to create a damp fog, then use the dry optical cleaning micro-fiber cloth provided to clean the lens surfaces. All other outside mechanical parts can be cleaned with a normal soft, clean and slightly damp cloth.

This micro-fiber cloth must remain free of any physical granular debris.

Proper storage

After using the riflescope, it is recommended to store it dry, in a well-ventilated room, at normal to low humidity levels, in normal room temperatures.

Spare parts

If you need spare parts or accessories for your riflescope, please contact an authorized dealer or GPO GmbH & Co. KG.

Technical specification

		1-8x24
Magnification		1 – 8x
Objective diameter	(mm)	24
Exit pupil diameter	(mm)	24 – 3
Field of view (FOV)	(m/100 m)	35 – 4,4
Eye relief	(mm)	90
Focal plane	(mm)	1
Travel value per click		1 cm
Elevation range total	(cm/100 m)	291
Windage range total	(cm/100 m)	291
Parallax compensation	(m)	100
Length	(mm)	273
Tube diameter	(mm)	34
Weight	(g)	770

Equipment

	1-8x24
Bikini covers	•
Lens cleaning cloth	•
Manual incl. return slip	•