



TA Series

Quick Start Guide

V2.0	202005
------	--------

Thank you for choosing our product. Please thoroughly go through user manual before operation and keep it well for future reference. All photos here are for reference only and specifications are subject to the physical product.

PUBLISHER'S INSTRUCTIONS

Our company shall not bear any legal responsibility for any mistake and accident caused by own reasons or reasons of any third party in the course of using this product by the user or property loss and personal injury caused by misjudgment against images. We prepare this guide with the purpose of facilitating users to use and understand our products. The contents of this guide are valid at the time of printing. We will try our best to ensure the accuracy of contents of this guide, but we still cannot ensure the completeness of contents of it. Since we have been continuously updating and upgrading our products, we reserve the right to modify this guide at any time without prior notice.

CAUTIONS

1. Do not directly expose the thermal imager to high intensity radiation sources such as the sun, carbon dioxide laser and electric welding machine.
2. As the thermal imager combines precision optical instruments and electrostatically sensitive electronic devices, do not throw, beat or vibrate the thermal imager and its accessories at will to avoid deformation of structural members or installation dimension.
3. To clean non-optical surfaces of the thermal imager, do not scrub with chemical solvent or diluent, and wipe the shell with a piece of clean, soft and dry flannel.
4. As a layer of anti-reflection film is coated on the infrared lens of the thermal imager, cleaning is required only when there is an obvious dirty, scrubbing the lens frequently may damage the coating of the lens.
5. After observation or when the target is not observed for a long period of time after power-on, power the thermal imager off in time to prolong its effective utilization time.
6. Do not disassemble the thermal imager by yourself. Contact the manufacturer in case of failure. Otherwise, we are not responsible for warranty repair.

1. ACCESSORIES

1.1 Standard Accessories



Portable C package



Blinder

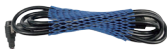

USB cable



Battery charger



Quick Start Guide



Warranty

1.2 Option Accessories



Video cable



Remote controller



Adapter ring A



Adapter ring B



Adapter ring C



PICATINNY rail



External eyepiece

2. PART NAME

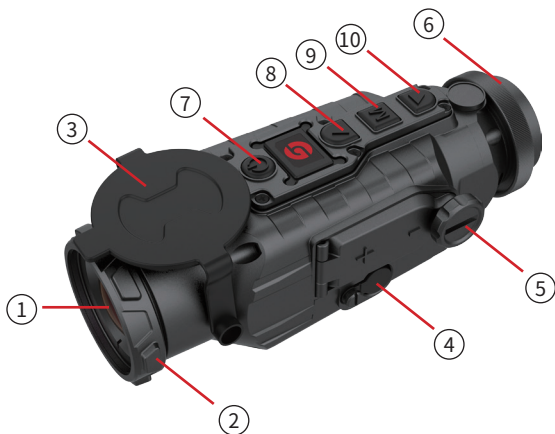

① Lens	⑥ Eyepiece
② Focusing Ring	⑦ Power Button
③ Lens Cover	⑧ Up Button
④ External Interface	⑨ Menu Button
⑤ Battery Cover	⑩ Down Button

3. PART DESCRIPTION

3.1 Lens

This guide is applicable to multiple lens series. The illustration shows only one of the lens models.

3.2 Focusing Ring

After the thermal imager is powered on, the image may be blurred when the distance to the observed target changes. And the lens focusing ring shall be turned to refocus until the target image is clear.

3.3 Lens Cover

Please cover the lens cap to protect the lens when the product is not in use!

3.4 External Interface

3.4.1 USB Cable

Through the external interface matching USB cable, can be connected to an external power supply, the battery is not used, directly to the product by an external power supply.

The output specification of the external power supply is 5V2A.

3.4.2 Video Cable

Through the external interface matching video cable, you can connect an external power supply and an external screen at the same time. While the product is powered by the external power supply, the camera image is output to an external monitor for display.

3.5 Battery Cover

When the product is used with batteries, it serves as the entrance to the battery.

The product's supporting battery model is CR123, and the continuous working time is related to the CR123 battery capacity and activity.

3.6 Eyepiece

It's the connection port for eye mask, external eyepiece and adapter rings.

3.7 Buttons

Buttons	Device current status	Short press		Long press	
Power button	Power-off	/	/	Power on	
	Power on	Calibration		Display off	Power-off
	Display off	Display on		/	
↑ Up button	No display in the menu bar	Switch to zoom mode		/	
	Display in the menu bar	Upward switching options	Change parameter value	/	
M Menu button	No display in the menu bar	Switch to scene mode		Enter the main menu	
	Display in the menu bar	Enter the sub-menu	Select option/ parameter value	Exit the menu bar / back to the previous menu	

↓ Down button	No display in the menu bar	Switch to color palettes mode	/
	Menu bar display	Downward switching options	/
Change parameter value			

4. FUNCTION DESCRIPTION

4.1 Power Button

4.1.1 Power On

Long press the power button to start the thermal imager, until a startup image is displayed in the eyepiece, power on.

4.1.2 Power-Off

4.1.2.1 Manual Power-Off

Long press the power button for display of power-off progress bar until the completion of the progress bar and the thermal imager is powered off.

4.1.2.2 Auto Power-Off

Time for auto power-off is settable, and if no button operation is carried out within such time, the thermal imager will be powered off.

4.2 Display off

Long press the power button to display the shutdown progress bar. Before the progress bar is completed, release the power button to cancel the shutdown and enter display off mode.

4.3 Display on

In display off mode, press any key to display on.

4.4 Calibration

Short press the power on/off button when power is on and the menu is not called out, to complete the corresponding calibration actions (except the automatic calibration).

4.5 Zoom-In

When power is on and the menu is not called out, short press up button in turn to trigger normal recycle switching for 2X/4X zoom in.

4.6 Scene Modes

When power is on and the menu is not called out, short press M button in turn to switch the scene modes of Enhance / Highlight / Nature.

4.7 Pseudo-Color Modes

When power is on and the menu is not called out, short press down button in turn to switch the pseudo-color modes of white hot, black hot, red hot, green hot.



























- White hot: Objects at relatively high temperature are displayed to be white or light grey.
- Black hot : Objects at relatively high temperature are displayed to be black or dark grey.
- Red hot: Objects at relatively high temperature are displayed to be red.

- Green hot : Resemble the LLL (night vision) image.

4.8 Menu

When power is on and the menu is not called out, long press M button to enter the main menu.

When power is on and the menu is called out, long press M button to exit the menu bar or back to the previous menu.

Icon	Icon meaning	Icon	Icon meaning
	Exit		Auto Stand-by
	Screen brightness		Auto power-off
	Calibration model		Restore default
	Automatic Calibration		Contrast
	Scene Calibration		Brightness
	Shutter Calibration		Position No.
	Video Output		Screen movement
	Video output is on		X-coordinate
	Hot point track		Y-coordinate
	Bluetooth		Save and Exit
	White hot		Red hot
	Black hot		Green hot
	Enhance		Nature
	Highlight		

1. Exit: To exit the menu bar.
2. Screen brightness: To adjust the grade of screen brightness. Grade 1-10 is adjustable.
3. Calibration model: To set a/an automatic calibration /scene calibration / shutter calibration, three types of calibration model.
4. Video Output: To open/close video output; when the video output is on, the icon will be displayed in the lower right corner of screen.
5. Hot point track: The switch can be set, and when hot point track is on, cursor will track the point with the highest temperature in the scene.
6. Bluetooth: When a Bluetooth is on, it will search and connect to a Bluetooth remote controller, after which is successfully done, all functions (except power on/off function) of buttons on the thermal imager can be controlled by this Bluetooth remote controller.
 - Bluetooth on: "Bluetooth is searching..." appears and then quickly disappears, while the Bluetooth icon flickers.
 - Successful Bluetooth connection: "Bluetooth connection success" appears and then quickly disappears, while the Bluetooth icon displays all the time.
 - Bluetooth connection failure: "Bluetooth connection failed" appears and then quickly disappears, and the

Bluetooth icon disappears.

Note: Bluetooth remote controllers are optional accessories.

7. Auto stand-by: Time for auto stand-by can be set, during which if no operation is carried out, it will enter into a stand-by mode.
8. Auto power-off: Time for auto power-off can be set, during which any operation will stop it from entering an auto power off mode.
9. Restore default: To select whether to restore the default. Select "yes" to restore all the parameters to factory settings;select" no" to cancel the operation.

Note: After the default value is restored, the device will power off automatically. Manually restart is required to take effect!

10. Contrast: The grade for image contrast can be adjusted and grade 1-10 is adjustable.
11. Brightness: The grade for image brightness can be adjusted and grade 1-10 is adjustable.

Note: The values of contrast and brightness adjustment are saved under the currently selected scene mode.

12. Position No.: Three groups of OLED screen position data can be saved. Each group of screen positions can be adjusted independently.

Please select the position number to be adjusted before using

the screen movement function.







13. Screen movement: Auxiliary adjustment of optical axis.

The light axis of the equipment has been calibrated before delivered, screen center coordinates (0, 0). If the optical axis shift occurs during use, you can use this function to correct the deviation urgently.

Note: The screen movement is an auxiliary function. Please use it when necessary.



5. BATTERY INDICATOR

When the thermal imager is powered on, the battery indicator will display in the upper right corner of the screen as the battery capacity levels changes. The alight part of the battery indicator indicates there maining capacity.

High capacity  Medium-high capacity 
Medium capacity  Medium-low capacity 
Low capacity  Scarce capacity 

- After power-on and entering a real-time image, the previous battery capacity levels shall be displayed in the upper right corner of the screen.

ATTENTION:

- **Replace the battery while the power is low!**
- **In the use of a rechargeable battery, the battery will be full for a longer time, that is, time for switching from  to  will be longer than that for switching between other battery capacity levels!**

The manual version will be updated after technical improvement.

