



NIGHT PEARL



NIGHT PEARL

**NIGHT PEARL
SEER 35 PRO**

Producer:
Night Pearl
Holesovska 1714
Bystrice pod Hostynem 768 61
The Czech Republic
T: +420 573 379 670
E: info@nightpearl.eu



OPERATION MANUAL

www.nightpearl.eu

www.nightpearl.eu

Manual version 1.2

ATTENTION!



The proper usage of the device is important for safe exploitation!
Therefore read carefully the present manual!



If the device was left in storage for a longer period of time, before exploitation check its functionality.



Disassembling of the device is prohibited, except in authorized repair centers.



The external optical surfaces should be clean at all times. Touching the optical surfaces with bare hands is not recommended.



Sand and sea water can damage the optical coatings!



Do not point the device directly at the sun!



Image performance is dependent on scenery and atmosphere conditions. Contrast in the same image may vary as a function of the time of day due to the effect of the sun. For example, at sunset objects will have absorbed different levels of heat resulting in greater temperature differences and better contrast.

ATTENTION!



Disposal of electrical equipment

This product is labeled in accordance with the European directive on the disposal of electrical and electronic equipment.

This symbol on the product or in the accompanying documentation indicates that the product after decommissioning must not be disposed of with your household waste, as it may contain substances dangerous for the environment. After decommissioning, return the product to a designated collection point for recycling or ecological disposal. For more detailed information on collection points contact your dealer or local office.



Battery disposal

Since used batteries and accumulators may contain substances dangerous for the environment, they are not to be disposed of with normal household waste. If device has replaceable batteries, please take them to an appropriate collection point for the purpose of disposal. For more detailed information on collection points contact your dealer or local office.



This product is marked with the European conformity mark in accordance with EU regulations.

The manufacturer hereby declares that the product is safe for its intended use and that during its manufacturing inspections and other measures are taken to ensure the conformity of the product with the essential requirements and technical documentation.

WARRANTY

The manufacturer provides a warranty 36 months for this product against manufacturing defects or malfunctions (after the purchase of the device by the first buyer)

The warranty does not cover malfunctions and defects caused by external influences or forces, improper handling, normal wear and tear, intervention by other than authorized service center personnel or as a result of operating and maintaining the device contrary to this user manual.

Company **ZÁHOŘÍ TRADE s.r.o.** shall not bear any legal responsibility for any mistake and accident caused by own reasons or reasons of any third party in the course of using this product by the user or property loss and personal injury caused by misjudgment against images. Import, export, sales and using this Night vision is controlled by Czech Republic Law system. All informations in this manual are only for end users. Content of this manual can be change only by Night Pearl brand, without any further notice. Distributors and manufacturer does not take any responsibilities cause by printing errors.

NOTES



When carrying or transporting the device, put the protective lens cap!



Condensation can cause fogging of the optical surfaces!
Condensation occurs when the temperature or humidity changes as follows:

- When moving the device from cold to warm place or vice versa;
- In places with high humidity.

When equalizing the temperature of the device with the environmental, the condensation disappears. Use the towel to remove moisture.



Clean the lens surfaces with the Lens Cloth or with the napkin!

LEGAL NOTICE

Before attaching to weapons, check the regional legal regulations in the area of application. The attachment to a weapon is always the sole responsibility of the user.



When left in storage for a longer period of time, batteries have to be removed and stored in polyethylene bags to prevent contact with metal. (It is recommended to recharge the batteries every two to three months)

APPEARANCE

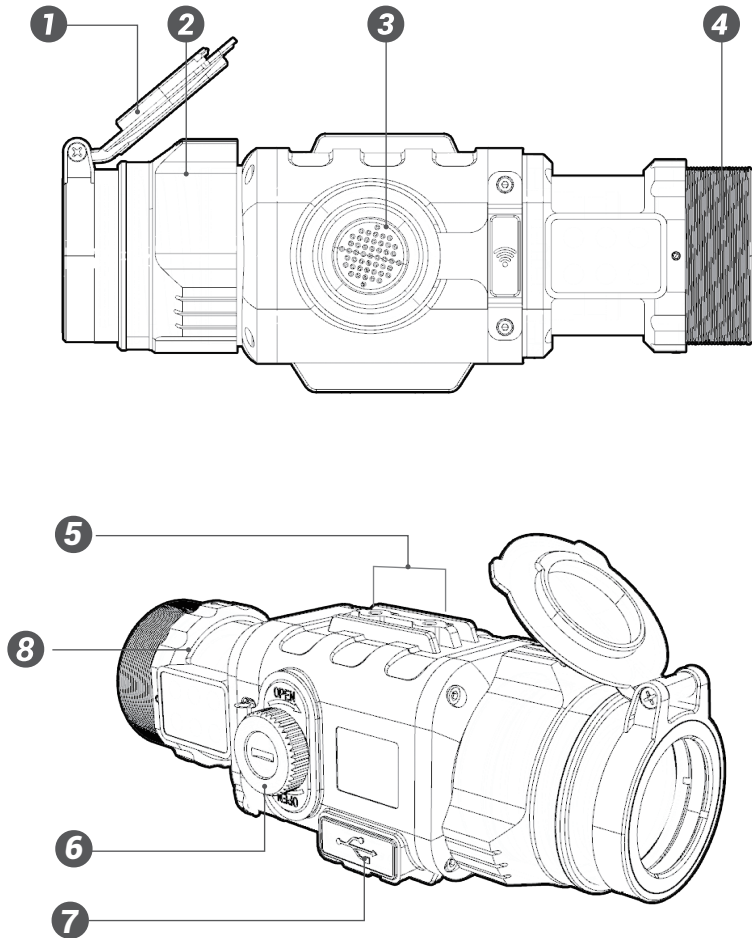

SPECIFICATIONS

Technical Data Sheet of SEER series

	SEER 35 PRO
Microbolometer	
Type	Uncooled
Resolution,pixels	384×288, Ceramic ASi
Frame Rate,Hz	50
Pixel size,um	17
Optical Characteristics	
Objective Lens	35mm,F/1.1
Magnification,X	1
Zoom*	2x/PIP/4x
Eye Relief,mm	24mm
Dioptre Adjustment,D	/
FOV	10.6°×8.0°
Close-up range,m	5
Display	
Type	OLED
Resolution,pixel	1024×768
DetectionRange (1.7m target)	1350
Recognition Range (1.7m)	450
DetectionRange (2.3m target)	1800
Recognition Range (2.3m)	600
Power Supply	
Battery Type	2XCR123
Power Supply	3.6~7.2v (2x CR123A)
External Power Supply	5v USB
Operation Time on a battery set(standard version),h	up to 5 hours depending on climatic conditions
Video recorder(optional)	
Video/Photo format	avi/jpg
Built-in memory(optional)	32G
Physical Parameters	
Degree of Protection	IP67
Operation Temperature	-40°C~+60°C
Storage Temperature	
Shock and Vibration	1200G
MTBF	More than 800h
Weight without batteries,g	495
Dimension,mm	175x70x63
C = Clip on H = Handheld	



STORAGE AND TRANSPORTATION

- Before storing it, clean obligatory the device (if on its surface there are moisture, dust or traces of dirt)!
- Make sure that there are no traces of moisture, and the battery compartment is empty!
- It is also possible for a short periods of time device to be stored in a suitable soft pack, bag or cartridge box.
- The premises in which the device is kept for long term have to be dry, enclosed, unheated and ventilated.
- During the storage should not be allowed exposure to aggressive environments, temperatures below -50°C and above +60°C, relative humidity greater than 80%, and prolonged periods of direct sunlight.
- Before each transportation, the product should be neatly packed in its original packaging (transport bag) and all other items and accessories should be carefully and steadily placed in the bag. After that the bag should be steadily placed in the transport suitcase.
- You can ship the product with all types of transport at different distances and at altitude up to 12 000 m.

MAINTENANCE AND CLEANING

- Protect the body of the device and the optical elements from falling, impact or other damage. When the device is not being used, its outer optical surfaces should be protected with the covers supplied. Storage the device in a clean dry protect case in a well-ventilated place.
- Dust deposited on the mechanical parts of the riflescope should be removed with a soft cloth.
- Moisten the cloth with fresh water and gently wipe the external surfaces (except for optical surfaces).
- After using the device in rain, thorough drying with a soft cloth is recommended.
- Do not touch the optics parts with fingers!
- To remove dirt from optical elements use only specially agents for optical (thermovision) parts
- Dust on the optical parts should be blown. You can use a lens brush and carefully remove all loose dirt from optical surfaces.
- Dampen a cotton swab with special detergent and lightly and slowly wipe optical surface. Clean the optical surface using circular movements, starting from the center and moving out towards the edge, not touching the lens holder and changing the cotton swab after each circular stroke. Repeat until the optical surface is clean.

NOTE

All images used in this instruction manual are for illustrative purpose only. Actual product may vary due to product enhancement.

- 1 Lens Cover**
- 2 Detachable focus ring**
- 3 OneTouch Button**
- 4 Thread for eyecup / adapter**
- 5 Attachment place**
- 6 Battery compartment cap**
- 7 2,5 Jack / Video output
Micro USB / Power bank connection
/ Service output**
- 8 Eyepiece**

CONTROLS

⚠ ATTENTION!

The main operations are performed through the "OneTouch Button" (5 position button) .

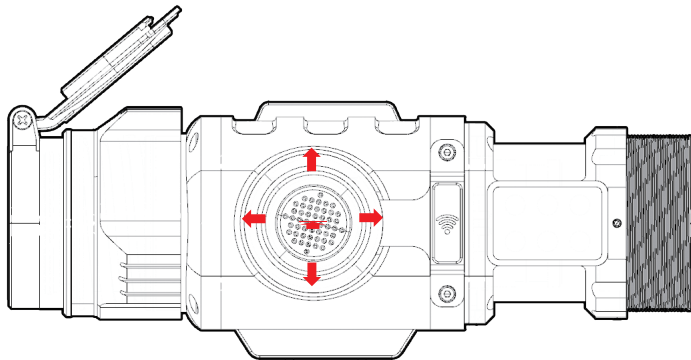

⚠ ATTENTION!

Turn off the device after usage, otherwise you can permanently damage the batteries!

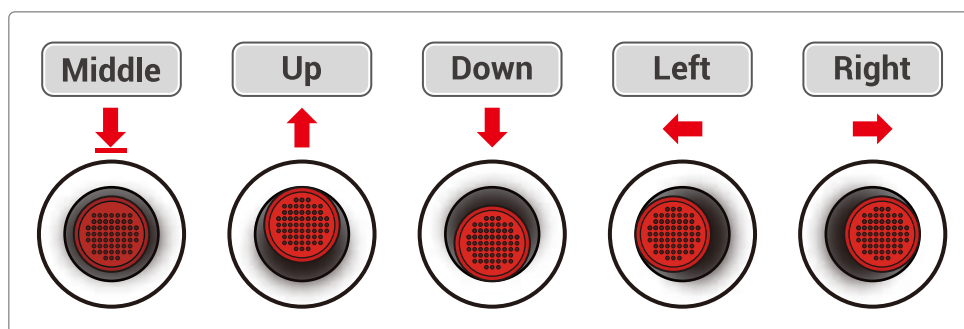

QUICK MENU / Wi-Fi / RECORDING

Wi-Fi function enables two ways of making photos and videos:

1. Photos and videos are made by the device and then automatically saved to internal storage.
2. Photos and videos are made using mobile device after it is connected to the SEER PLUS via Wi-Fi. Photo and video recording are made by mobile device and saved directly to it.

ad 1.

- Turn Wi-Fi on and wait for 10s
- With short press of joystick to the right make photos and wait for 10s
- With long press of joystick to the right turn on/off video recording and wait for 10s
- When you take photos/video recording, do not press too quickly, always wait until 001 disappears before you take 002.
- Wait about 10 seconds to save all files and turn off Wi-Fi!

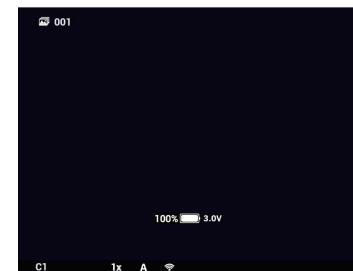

- For viewing and arranging photos/videos connect your device to PC using USB cable (make sure that there are batteries in the device)
- Turn device on and activate Wi-Fi
- In PC successively click: Camera=> Internal Storage => DCIM => 001

Step 1.



Step 2.



Step 3.



Step 4.



ad 2.

- Turn Wi-Fi on
- Download Cam802 application to your mobile device from App Store
- Device will appear under NightPearl name
- Password for WIFI connection is 12345678

Notice! When the device is connected to a PC, low batteries in the device may prevent photos and videos from being transferred to PC.

CABLE CONNECTION

2,5 Jack  enables the connection with an external display monitor.

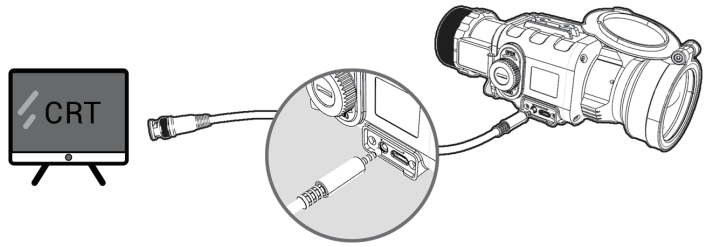



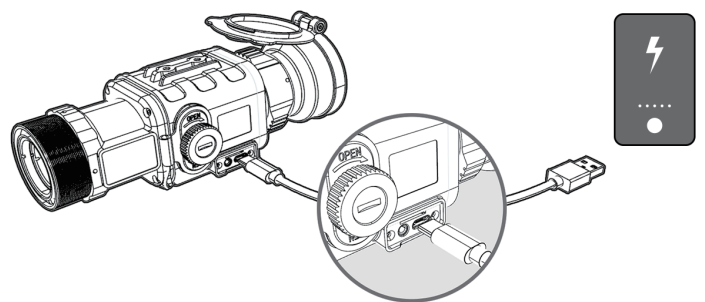

Micro USB  to power from the power bank / for service output (enables updating your device to latest version) Contact your local distributor for update service.



WARNING:

When using the power bank, the battery charge status indication is not active. The battery charge level icon displayed in the status bar is replaced by an icon indicating the connection of an external charging source .

For the best displaying of menu we recommend using 3x rifle scope magnification.

BUTTON	DEVICE STATUS (Current operating mode)	SHORT PRESS	LONG PRESS
Middle 	Real time image	NUC	ON / OFF
	Quick menu	EXIT quick menu	
	Main menu	Confirm selection	
Up 	Real time image	Bring out quick menu	Enter main menu
	Quick menu	Change parameters	
	Main menu	Change parameters	
Down 	Real time image	Bring out quick menu	Enter power save mode
	Quick menu	Change parameters	
	Main menu	Change parameters	
Left 	Real time image	Bring out quick menu	Battery settings 3.0V / 3.7V
	Quick menu	Switch function	NA
	Main menu	Select setting options	
Right 	Real image	NA	
	Quick menu	Switch function	
	Main menu	Select setting options	
	WIFI on	Take photo	

NOTE: Photo and video taking function are only valid when WIFI is on.

POWER SAVE MODE

Longer press the Down button (Joystick) to enter the power saving mode. The display turns off. Press any button to deactivate Power Save mode.

STATUS BAR

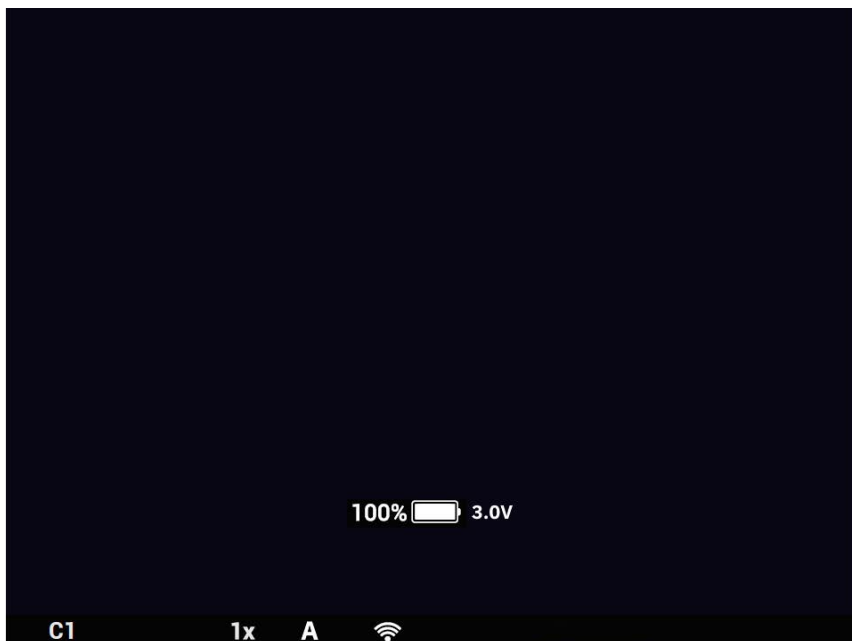

The status bar is located in the lower part of the display and shows information on the actual operating status of the sight, including:

- Color palette
C1~C5
- Current digital zoom magnification
- Wifi connection
- Battery charge level indication

BATTERY INSTALLATION

Turn the battery compartment knob clockwise until stop and remove it. Install two CR123A (3.0 V nebo 3.7V) batteries in opposite polarity direction.

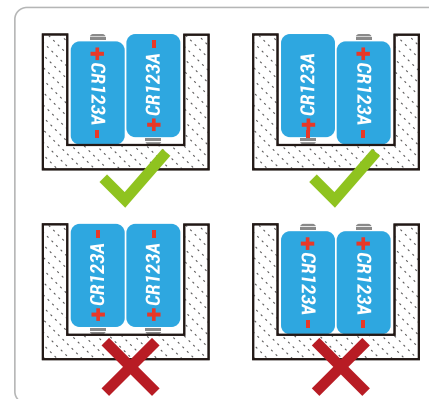

Install battery compartment and press it until it clicks - make sure the cover is closed on both sides.

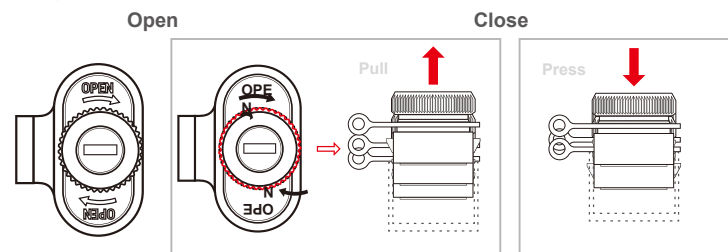

Battery type setting

For the correct function of the device, it is necessary to set the model of inserted batteries. Otherwise, the battery charge level may be displayed incorrectly and the device may turn off suddenly.

Power ON the device. Press and hold the control button to the left to select the type of batteries inserted (3.0 V or 3.7 V). The currently selected battery type will be displayed next to the battery level icon.

WARNING

We recommend the use batteries with a voltage of 3.0 or 3.7 V. Do not use rechargeable batteries! Please do not use batteries of different types or batteries with various charge levels.

Using rechargeable batteries can cause inaccurate battery level indication and possible disconnection during operation.

The battery charge level is displayed on the status bar



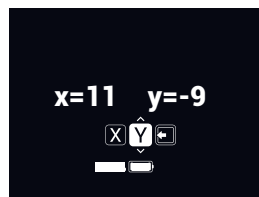
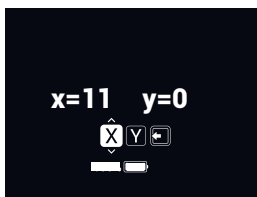

QUICK MENU

The Quick menu allows change of basic settings. Enter the Quick menu with a short press of button in Up/Down/Left. To toggle between the functions below, press Left or Right button when Quick menu is in display. If nothing is done in quite menu for 5 seconds it will disappear.

ATTENTION!

For the best displaying of menu we recommend using 3x rifle scope magnification. To permanently save changes of the device settings, switch the device off and then switch it on with a long press on the control button (joystick) after changes have been applied. If the device is switched off in any other way – e.g. due to battery discharge or power bank disconnection, the last changes made will not be saved!



Zoom

Press the Up/Down buttons to change digital zoom from 1X,2X,4X and PIP. Picture in inset window under PIP mode is 2X digital zoom.

Attention: Digital magnification 2x, 4x and PIP are not available for Clip-onmode



Palette

Basic image mode is "White Hot". Press the Up/Down buttons to select palette - from C1~C5



Brightness

Press the Up/Down buttons to change image brightness from 0~9. (Available only for Picture mode B and C)



Contrast

Press the Up/Down buttons to change display contrast from 0~9. (Available only for Picture mode B and C)



Sharpness

Select one of the sharpness aside with a short press of Up / Down. (Available only for Picture mode B and C)



Manual Calibration

Press the Up/Down buttons for manual Calibration. **Close the Lens Cover before calibration!**



Wi-Fi

See quick menu / Wi-Fi
Video format / AVI, Photo format / JPG, Built-in memory 32 G WIFI Frequency 2,4,
Reception range 15m



Picture mode

Mode A is the standard mode and can only be viewed with the default settings
Mode B is an enhanced mode, which highlights more image details. Available manual adjustment of sharpening, brightness, contrast parameters
Mode C is the standard mode with adjustable sharpening, brightness and contrast (edited)



MAIN MENU

Enter the main menu with a long press of the Up button. Press the Left/Right buttons to select between the main menu options.
To permanently save changes of the device settings, switch the device off and then switch it on with a long press on the control button (joystick) after changes have been applied. If the device is switched off in any other way – e.g. due to battery discharge or power bank disconnection, the last changes made will not be saved!



Press the Up/Down button to Exit Main Menu. Main Menu will not disappear automatically.

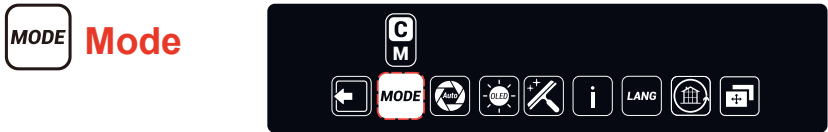

Press Up/Down to change your thermal imager to clip on mode. All menu is displayed in the central area of the image. The reason is the reduced field of view of the daysight by higher magnifications. Reaching a low battery state the device gives a warning in the top left corner of the central area. (M=Monocular C = Clip on.)

ATTENTION! Accurate shooting is only guaranteed when the clip-on mode is set!

NOTE : It is recommended to use up to 3x magnification of the primary optical unit in order to keep the menu and all submenus visible in clip-on mode.



Press the Up/Down button to turn Automatic Non-uniformity Calibration On / Off. In the automatic mode the need for calibration is based on software algorithm, calibration starts automatically. When choose Off, user will do calibration manually by either lens cover (silent without shutter) or press middle button (with shutter). Manual calibration function is in Quick Menu .



Press the Up / Down buttons to change OLED brightness from 0 , 1 , 2 .



Defective Pixel Repair

Press Up/Down buttons then close lens cover to repair defective pixel. Defective pixels are found by software algorithm.



Restore Default Setting

Press Up/Down buttons to Restore Default Setting, there will be no further indication. The following settings will be restored to their original values before changes made by user : Zoom, Image Brightness, Contrast, Sharpness, OLED Brightness

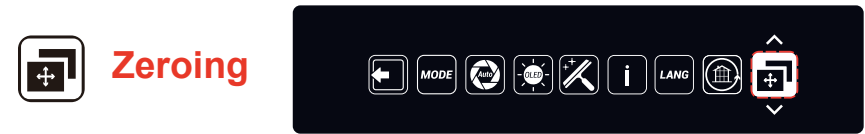

Zeroing

This post production zeroing is performed at 50m range. If necessary, set up the device for your weapon as follows:

1. Aim your scope without SEER to the middle of target and shoot. Thus, making sure that your scope is accurate.
2. Put SEER on the rifle scope using adapter and fix it. Aim to the center of the target using heat source (e.g. hand warmer) and shoot again.
3. Measure horizontal distance (X) and vertical distance (Y) between shoot and aiming point
4. Long press joystick Up to enter main menu, you will see Alignment Correction as the last icon of the menu. Short press joystick Up to enter this sub-menu.
5. By pressing joystick Left or Right move between X, Y and EXIT. Pressing Up increases value (X+, Y+), pressing Down decreases value (X-, Y-).
6. The setting is saved by pressing EXIT button with Up or Down joystick movement.
7. [garbled text]
8. If point of impact with SEER is on the top of previous point of impact, decrease Y value (Y- by pressing joystick Down). If point of impact with SEER is on the bottom of previous point of impact, increase Y value (Y+ by pressing joystick Up)
9. While using the Alignment Correction value of axis X and Y are shown in sub-menu, where 1 click for: NP SEER 35 PRO is 1,66 MOA = 4.8cm on 100m
10. Control if the values are saved correctly!